

Approval body for construction products
and types of construction

Bautechnisches Prüfamt

An institution established by the Federal and
Laender Governments



European Technical Assessment

ETA-22/0247
of 3 June 2022

English translation prepared by DIBt - Original version in German language

General Part

Technical Assessment Body issuing the
European Technical Assessment:

Deutsches Institut für Bautechnik

Trade name of the construction product

CELO Injection system ResiFIX Pure Epoxy
for rebar connection

Product family
to which the construction product belongs

Systems for post-installed
rebar connections with mortar

Manufacturer

CELO Befestigungssysteme GmbH
Industriestraße 6
86551 Aichach
DEUTSCHLAND

Manufacturing plant

Werk2, Deutschland

This European Technical Assessment
contains

19 pages including 3 annexes which form an integral part
of this assessment

This European Technical Assessment is
issued in accordance with Regulation (EU)
No 305/2011, on the basis of

EAD 330087-01-0601, Edition 06/2021

The European Technical Assessment is issued by the Technical Assessment Body in its official language. Translations of this European Technical Assessment in other languages shall fully correspond to the original issued document and shall be identified as such.

Communication of this European Technical Assessment, including transmission by electronic means, shall be in full. However, partial reproduction may only be made with the written consent of the issuing Technical Assessment Body. Any partial reproduction shall be identified as such.

This European Technical Assessment may be withdrawn by the issuing Technical Assessment Body, in particular pursuant to information by the Commission in accordance with Article 25(3) of Regulation (EU) No 305/2011.

Specific Part

1 Technical description of the product

The subject of this European Technical Assessment is the post-installed connection, by anchoring or overlap connection joint, of reinforcing bars (rebars) in existing structures made of normal weight concrete, using the "CELO Injection system ResiFIX Pure Epoxy for rebar connection" in accordance with the regulations for reinforced concrete construction.

Reinforcing bars made of steel with a diameter ϕ from 8 to 40 according to Annex A and injection mortar ResiFIX Pure Epoxy EPSF are used for rebar connections. The rebar is placed into a drilled hole filled with injection mortar and is anchored via the bond between rebar, injection mortar and concrete.

The product description is given in Annex A.

2 Specification of the intended use in accordance with the applicable European assessment Document

The performances given in Section 3 are only valid if the rebar connection is used in compliance with the specifications and conditions given in Annex B.

The verifications and assessment methods on which this European Technical Assessment is based lead to the assumption of a working life of the rebar connection of at least 50 years. The indications given on the working life cannot be interpreted as a guarantee given by the producer, but are to be regarded only as a means for choosing the right products in relation to the expected economically reasonable working life of the works.

3 Performance of the product and references to the methods used for its assessment

3.1 Mechanical resistance and stability (BWR 1)

Essential characteristic	Performance
Characteristic resistance under static and quasi-static loading	See Annex C 1
Characteristic resistance under seismic loading	No performance assessed

3.2 Safety in case of fire (BWR 2)

Essential characteristic	Performance
Reaction to fire	Class A1
Resistance to fire	See Annex C 2

4 Assessment and verification of constancy of performance (AVCP) system applied, with reference to its legal base

In accordance with European Assessment Document EAD No. 330087-01-0601, the applicable European legal act is: [96/582/EC].

The system(s) to be applied is (are): 1

5 Technical details necessary for the implementation of the AVCP system, as provided for in the applicable European Assessment Document

Technical details necessary for the implementation of the AVCP system are laid down in the control plan deposited with Deutsches Institut für Bautechnik.

Issued in Berlin on 3 June 2022 by Deutsches Institut für Bautechnik

Dipl.-Ing. Beatrix Wittstock
Head of Section

beglaubigt:
Baderschneider

Installation post installed rebar

Figure A1: Overlapping joint for rebar connections of slabs and beams

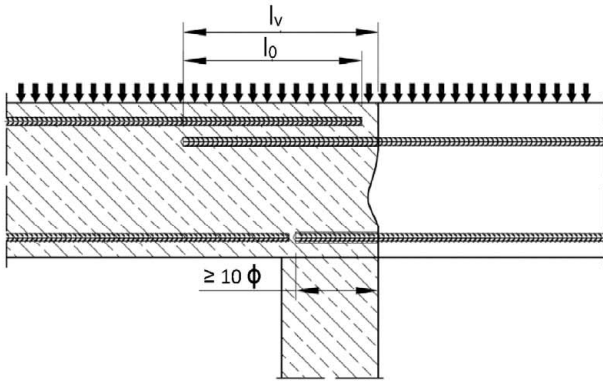

Figure A2: Overlapping joint at a foundation of a wall or column where the rebars are stressed in tension

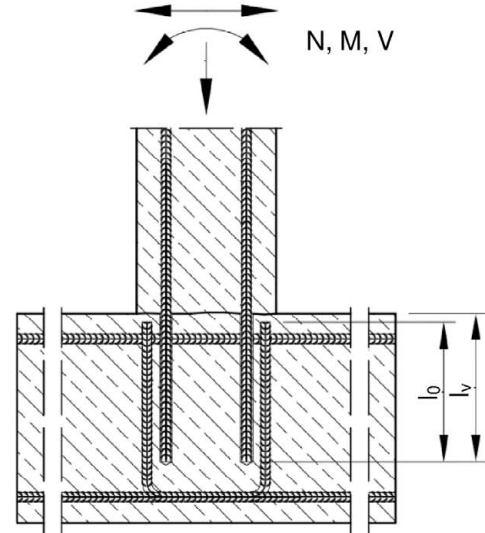

Figure A3: End anchoring of slabs or beams (e.g. designed as simply supported)

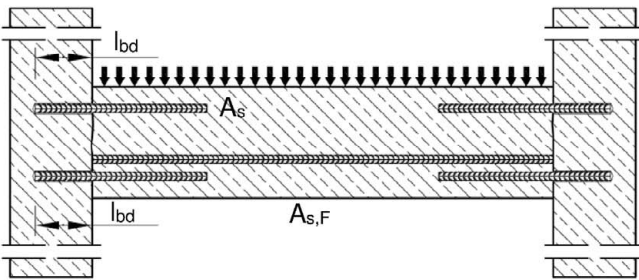

Figure A4: Rebar connection for components stressed primarily in compression. The rebars are stressed in compression

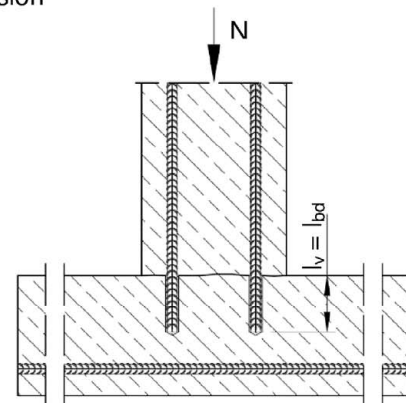
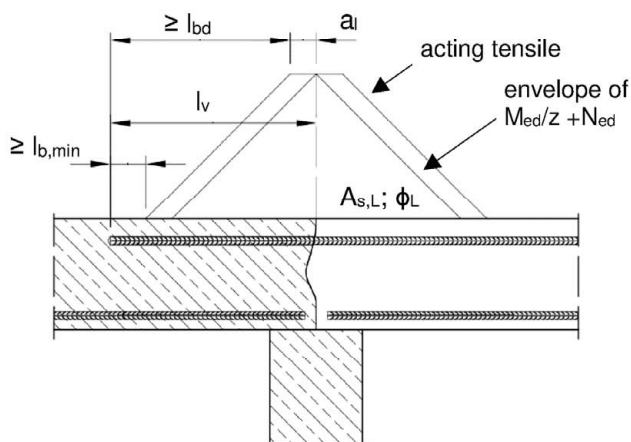

Figure A5: Anchoring of reinforcement to cover the line of acting tensile force



Note to Figure A1 to A5:

In the Figures no transverse reinforcement is plotted, the transverse reinforcement shall comply with EN 1992-1-1:2004+AC:2010.

Preparing of joints according to Annex B 2

CELO Injection system ResiFIX Pure Epoxy for rebar connection

Product description
Installed condition and examples of use for rebars

Annex A 1

Cartridge system

Side-by-Side Cartridge:
440 ml, 585 ml and 1400 ml

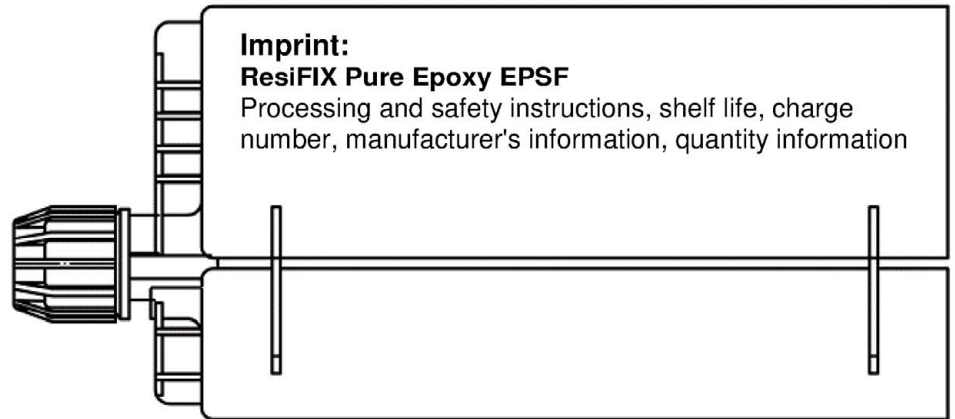

Static mixer MDE

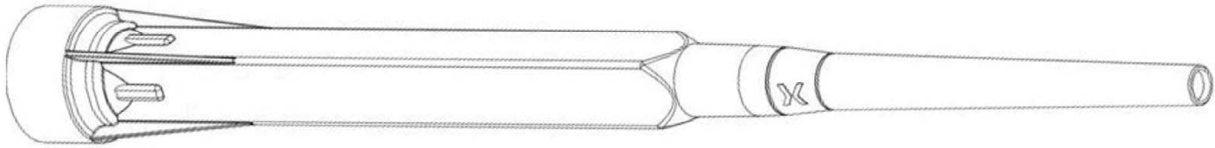

Piston plug VS und mixer extension VL



CELO Injection system ResiFIX Pure Epoxy for rebar connection

Product description
Injection system

Annex A 2

Reinforcing bar (rebar): $\varnothing 8$ up to $\varnothing 40$

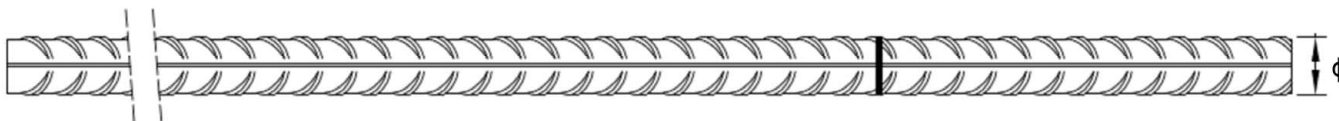

- Minimum value of related rip area $f_{R,min}$ according to EN 1992-1-1:2004+AC:2010
- Rib height of the bar shall be in the range $0,05\phi \leq h_{rib} \leq 0,07\phi$
(ϕ : Nominal diameter of the bar; h_{rib} : Rib height of the bar)

Table A1: Materials Rebar

Designation	Material
Rebar EN 1992-1-1:2004+AC:2010, Annex C	Bars and de-coiled rods class B or C f_{yk} and k according to NDP or NCI of EN 1992-1-1/NA $f_{uk} = f_{tk} = k \cdot f_{yk}$

CELO Injection system ResiFIX Pure Epoxy for rebar connection

Product description
Materials Rebar

Annex A 3

Specification of the intended use			
Anchorage subject to:		Working life 50 years	Working life 100 years
HD: Hammer drilling HDB: Hammer drilling with hollow drill bit CD: Compressed air drilling DD: Diamond drilling	static and quasi-static loads	Ø8 to Ø40	No performance assessed
	seismic action	No performance assessed	No performance assessed
	Fire exposure	Ø8 to Ø40	No performance assessed
Temperature Range:	- 40°C to +80°C (max long-term temperature +50 °C and max short-term temperature +80 °C)		
Base materials:			
<ul style="list-style-type: none"> - Reinforced or unreinforced normal weight concrete according to EN 206:2013 + A1:2016. - Strength classes C12/15 to C50/60 according to EN 206:2013 + A1:2016. - Maximum chloride content of 0,40% (CL 0.40) related to the cement content according to EN 206:2013 + A1:2016. - Non-carbonated concrete. <p>Note: In case of a carbonated surface of the existing concrete structure the carbonated layer shall be removed in the area of the post-installed rebar connection with a diameter of $\phi + 60$ mm prior to the installation of the new rebar.</p> <p>The depth of concrete to be removed shall correspond to at least the minimum concrete cover in accordance with EN 1992-1-1:2004+AC:2010. The foregoing may be neglected if building components are new and not carbonated and if building components are in dry conditions.</p>			
Design:			
<ul style="list-style-type: none"> - Anchorages are designed under the responsibility of an engineer experienced in anchorages and concrete work. - Verifiable calculation notes and drawings are prepared taking account of the forces to be transmitted. - Design according to EN 1992-1-1:2004+AC:2010, EN 1992-1-2:2004+AC:2008 and Annex B 2. - The actual position of the reinforcement in the existing structure shall be determined on the basis of the construction documentation and taken into account when designing. 			
Installation:			
<ul style="list-style-type: none"> - Dry or wet concrete. It must not be installed in flooded holes. - Overhead installation allowed. - Hole drilling by hammer drill (HD), hollow drill (HDB), diamond drill (DD) or compressed air drill mode (CD). - The installation of post-installed rebar resp. tension anchors shall be done only by suitable trained installer and under supervision on site; the conditions under which an installer may be considered as suitable trained and the conditions for supervision on site are up to the Member States in which the installation is done. - Check the position of the existing rebars (if the position of existing rebars is not known, it shall be determined using a rebar detector suitable for this purpose as well as on the basis of the construction documentation and then marked on the building component for the overlap joint). 			
CELO Injection system ResiFIX Pure Epoxy for rebar connection			Annex B 1
Intended use Specifications			

Figure B1: General construction rules for post-installed rebars

- Only tension forces in the axis of the rebar may be transmitted.
- The transfer of shear forces between new concrete and existing structure shall be designed additionally according to EN 1992-1-1:2004+AC:2010.
- The joints for concreting must be roughened to at least such an extent that aggregate protrude.

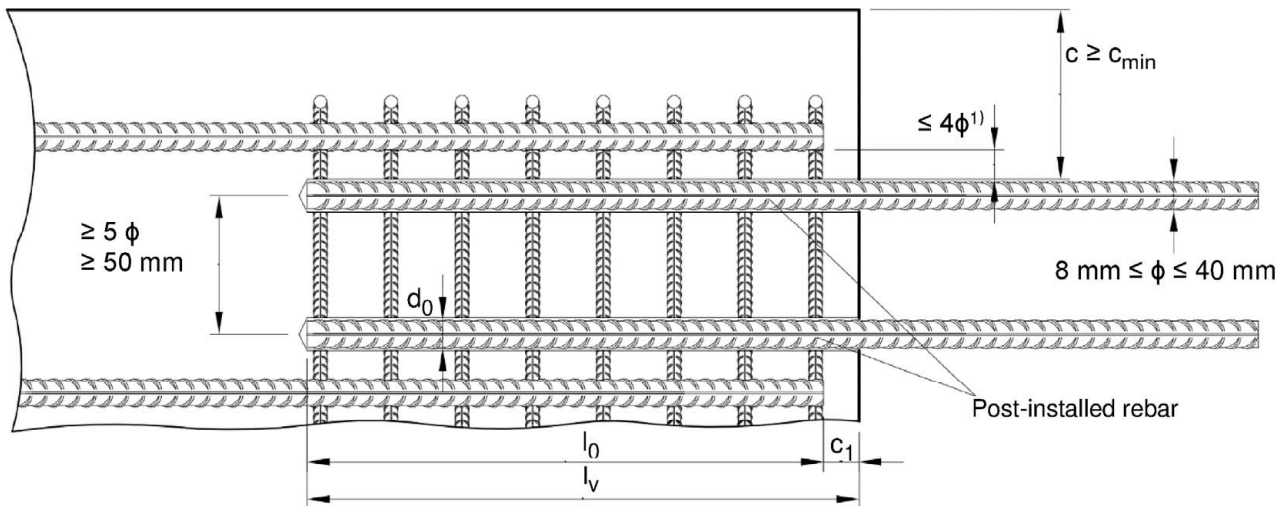

1) If the clear distance between lapped bars exceeds 4ϕ , then the lap length shall be increased by the difference between the clear bar distance and 4ϕ .

The following applies to Figure B1:

c	concrete cover of post-installed rebar
c_1	concrete cover at end-face of existing rebar
c_{\min}	minimum concrete cover according to Table B1 and to EN 1992-1-1:2004+AC:2010, Section 4.4.1.2
ϕ	diameter of post-installed rebar
l_0	lap length, according to EN 1992-1-1:2004+AC:2010, Section 8.7.3
l_v	effective embedment depth, $\geq l_0 + c_1$
d_0	nominal drill bit diameter, see Annex B 4

CELO Injection system ResiFIX Pure Epoxy for rebar connection

Intended use
General construction rules for post-installed rebars

Annex B 2

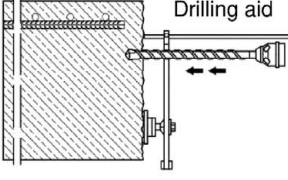

Table B1: Minimum concrete cover $c_{\min}^{1)}$ of post-installed rebar and tie rod depending of drilling method				
Drilling method	Rebar diameter	Without drilling aid	With drilling aid	
HD: Hammer drilling HDB: Hammer drilling with hollow drill bit	< 25 mm	$30 \text{ mm} + 0,06 \cdot l_v \geq 2 \phi$	$30 \text{ mm} + 0,02 \cdot l_v \geq 2 \phi$	
	$\geq 25 \text{ mm}$	$40 \text{ mm} + 0,06 \cdot l_v \geq 2 \phi$	$40 \text{ mm} + 0,02 \cdot l_v \geq 2 \phi$	
DD: Diamond drilling	< 25 mm	Drill rig used as drilling aid	$30 \text{ mm} + 0,02 \cdot l_v \geq 2 \phi$	
	$\geq 25 \text{ mm}$		$40 \text{ mm} + 0,02 \cdot l_v \geq 2 \phi$	
CD: Compressed air drilling	< 25 mm	$50 \text{ mm} + 0,08 \cdot l_v$	$50 \text{ mm} + 0,02 \cdot l_v$	
	$\geq 25 \text{ mm}$	$60 \text{ mm} + 0,08 \cdot l_v \geq 2 \phi$	$60 \text{ mm} + 0,02 \cdot l_v \geq 2 \phi$	
<p>1) see Annex B 2, Figure B1 Comments: The minimum concrete cover acc. EN 1992-1-1:2004+AC:2010 must be observed.</p>				
Table B2: Dispensing tools				
Cartridge type/size	Hand tool		Pneumatic tool	
Side-by-side cartridges 440 and 585 ml				
	e.g. SA 296C585	e.g. Typ H 244 C	e.g. Typ TS 444 KX	
Side-by-side cartridges 1400 ml	-	-		
			e.g. Typ TS 471	
All cartridges could also be extruded by a battery tool.				
CELO Injection system ResiFIX Pure Epoxy for rebar connection			Annex B 3	
Intended use Minimum concrete cover Dispensing, cleaning and installation tools				

Table B3: Brushes, piston plugs, max anchorage depth and mixer extension, hammer (HD), diamond (DD) and compressed air (CD) drilling

Bar size ϕ	Drill bit - \emptyset			d_b Brush - \emptyset	$d_{b,min}$ min. Brush - \emptyset	Piston plug	Cartridge: 440 ml or 585 ml				Cartridge : 1400 ml								
	HD	DD	CD				Hand or battery tool		Pneumatic tool		Pneumatic tool								
							$l_{v,max}$	Mixer extension	$l_{v,max}$	Mixer extension	$l_{v,max}$	Mixer extension							
[mm]	[mm]			[mm]	[mm]		[mm]		[mm]		[mm]								
8	10	-		RB10	11,5	10,5	-	250	VL10/0,75 or VL16/1,8	1300	VL10/0,75 or VL16/1,8	250	VL10/0,75 or VL16/1,8						
				RB12	13,5	12,5	-	700				800		250					
10	12	-		RB14	15,5	14,5	VS14	700				1000		1000	250				
				RB16	17,5	16,5	VS16	700				1300		1200					
12	14	-		RB18	20,0	18,5	VS18	700				1300		1400	1400				
14	18	-		RB20	22,0	20,5	VS20	700				1300		1600	1600				
20	25	-		RB25	27,0	25,5	VS25	500				1000		2000	VL16/1,8				
	-	26		RB26	28,0	26,5	VS26												
22	28	-		RB28	30,0	28,5	VS28									500	1000	2000	VL16/1,8
24/25	30	-		RB30	32,0	30,5	VS30									500	1000	2000	VL16/1,8
	32	-		RB32	34,0	32,5	VS32		500	1000	2000		VL16/1,8						
28	35	-		RB35	37,0	35,5	VS35		500	1000	2000		VL16/1,8						
32/34	40	-		RB40	43,5	40,5	VS40		500	1000	2000		VL16/1,8						
36	45	-		RB45	47,0	45,5	VS45		500	1000	2000		VL16/1,8						
40	-	52	52	RB52	54,0	52,5	VS52		-	-	-		-						
	55	-	55	RB55	58,0	55,5	VS55		-	-	-		-						

Table B4: Brushes, piston plugs, max anchorage depth and mixer extension, hammer drilling with hollow drill bit system (HDB)

Bar size ϕ	Drill bit - \emptyset		d_b Brush - \emptyset	$d_{b,min}$ min. Brush - \emptyset	Piston plug	Cartridge: 440 ml or 585 ml				Cartridge : 1400 ml			
	HDB					Hand or battery tool		Pneumatic tool		Pneumatic tool			
						$l_{v,max}$	Mixer extension	$l_{v,max}$	Mixer extension	$l_{v,max}$	Mixer extension		
[mm]	[mm]				[mm]		[mm]		[mm]				
8	10	No cleaning Required			-	250	VL10/0,75 oder VL16/1,8	1000	VL10/0,75 oder VL16/1,8	1000	VL10/0,75 oder VL16/1,8		
	12				-	700						800	250
10	14				VS14	700						1000	1000
					VS16	700						1300	1200
12	16				VS18	700						1300	1400
14	18				VS20	700						1300	1600
16	20				VS25	700						1300	1600
20	25				VS28	700						1300	1600
22	28				VS30	700						1300	1600
24/25	30				VS32	700						1300	1600
	32	VS35	700	1300	1600								
28	35	VS40	700	1300	1600								
32/34	40												

CELO Injection system ResiFIX Pure Epoxy for rebar connection

Intended Use

Parameter brushes, piston plugs, max anchorage depth and mixer extension

Annex B 4

Cleaning and installation tools

HDB – Hollow drill bit system



The hollow drill system consists of Heller Duster Expert hollow drill bit and a class M Hoover with a minimum negative pressure of 253 hPa and a flow rate of minimum 150 m³/h (42 l/s).

Hand pump

(Volume 750 ml, $h_0 \geq 10 d_s$, $d_0 \leq 20\text{mm}$)



Manual slide valve

(min 6 bar)



Brush RB



Pistole Plug VS



Brush extension RBL



Table B5: Working time and curing time

Temperature in base material			Maximum working time	Minimum curing time ¹⁾
T			t_{work}	t_{cure}
+ 5 °C	up to	+ 9 °C	80 min	60 h
+ 10 °C	up to	+ 14 °C	60 min	48 h
+ 15 °C	up to	+ 19 °C	40 min	24 h
+ 20 °C	up to	+ 24 °C	30 min	12 h
+ 25 °C	up to	+ 34 °C	12 min	10 h
+ 35 °C	up to	+ 39 °C	8 min	7 h
		+40 °C	8 min	4 h
Cartridge temperature			+5 °C up to +40 °C	

1) The minimum curing time is only valid for dry base material.
In wet base material the curing time must be doubled.

CELO Injection system ResiFIX Pure Epoxy for rebar connection

Intended Use

Cleaning and installation tools
Working time and curing time

Annex B 5

Installation instructions

Attention: Before drilling, remove carbonated concrete and clean contact areas (see Annex B1)

In case of aborted drill hole: the drill hole shall be filled with mortar.

Drilling of the bore hole

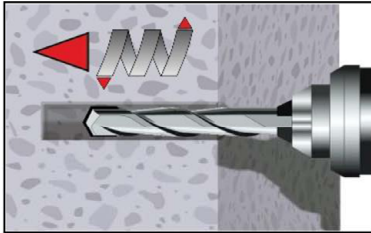

1a. Hammer drilling (HD) / Compressed air drilling (CD)

Drill a hole to the required embedment depth.
Drill bit diameter according to Table B3.
Proceed with Step 2 (MAC or CAC).

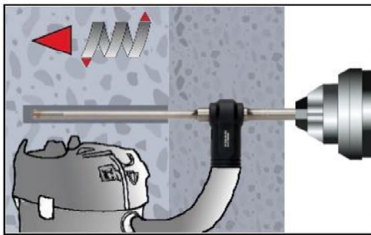

1b. Hollow drill bit system (HDB) (see Annex B 5)

Drill a hole to the required embedment depth.
Drill bit diameter according to B4.
The hollow drilling system removes the dust and cleans the bore hole.
Proceed with Step 3.

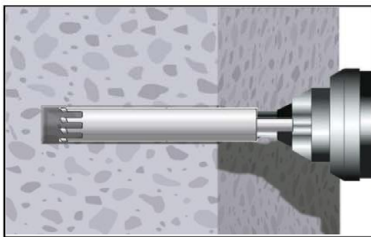

1c. Diamond drilling (DD)

Drill a hole to the required embedment depth required
Drill bit diameter according to Table B3.
Aborted drill holes shall be filled with mortar.
Proceed with Step 2 (SPCAC).

CELO Injection system ResiFIX Pure Epoxy for rebar connection

Intended use
Installation instruction

Annex B 6

Installation instructions (continuation)

Manual Air Cleaning (MAC)

for drill hole diameter $d_0 \leq 20\text{mm}$ and drill hole depth $h_0 \leq 10\phi$, with drilling method HD/CD

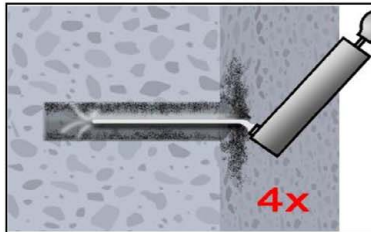

Attention! Standing water in the bore hole must be removed before cleaning.

2a. Blow the bore hole clean minimum 4x from the bottom or back by hand pump (Annex B 5).

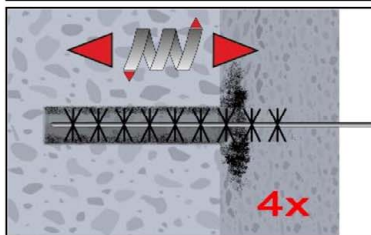

2b. Brush the bore hole minimum 4x with brush RB according to Table B3 over the entire embedment depth in a twisting motion (if necessary, use a brush extension).

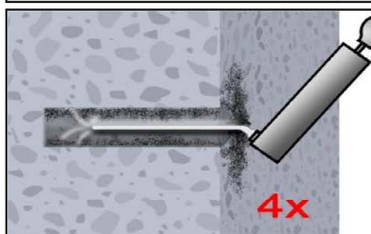

2c. Finally blow the bore hole clean minimum 4x from the bottom or back by hand pump (Annex B 5).

Compressed Air Cleaning (CAC):

All diameter with drilling method HD/CD

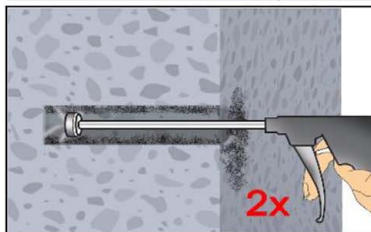

Attention! Standing water in the bore hole must be removed before cleaning.

2a. Blow the bore hole clean minimum 2x with compressed air (min. 6 bar) (Annex B 5) over the entire embedment depth until return air stream is free of noticeable dust. (If necessary, an extension shall be used.)

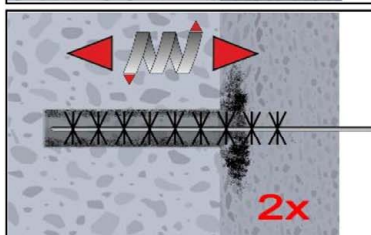

2b. Brush the bore hole minimum 2x with brush RB according to Table B3 over the entire embedment depth in a twisting motion. (If necessary, a brush extension shall be used.)

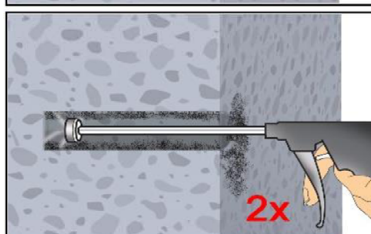

2c. Finally blow the bore hole clean minimum 2x with compressed air (min. 6 bar) (Annex B 5) over the entire embedment depth until return air stream is free of noticeable dust. (If necessary, an extension shall be used.)

Protect cleaned bore hole against re-contamination in an appropriate way. If necessary, repeat cleaning process directly before dispensing the mortar. In-flowing water must not contaminate the bore hole again.

CELO Injection system ResiFIX Pure Epoxy for rebar connection

Intended use

Installation instructions (continuation)

Annex B 7

Installation instructions (continuation)

Flush & Compressed Air Cleaning (SPCAC):

All diameter with drilling method DD

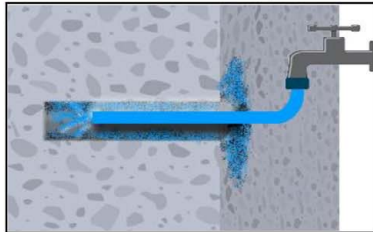

2a. Flushing with water until clear water comes out.

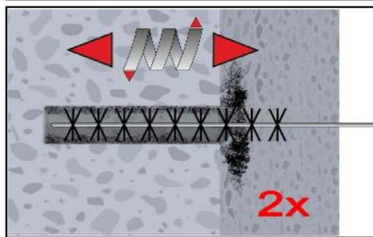

2b. Brush the bore hole minimum 2x with brush RB according to Table B4 over the entire embedment depth in a twisting motion. (If necessary, a brush extension shall be used.)

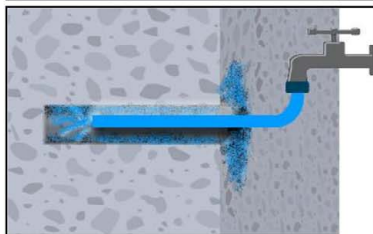

2c. Flushing again with water until clear water comes out.

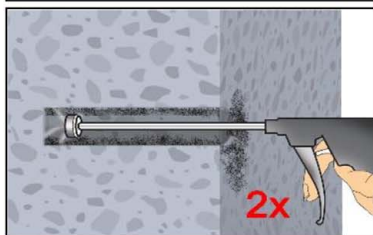

2d. Blow the bore hole clean minimum 2x with compressed air (min. 6 bar) (Annex B 4) over the entire embedment depth until return air stream is free of noticeable dust. (If necessary, an extension shall be used.)

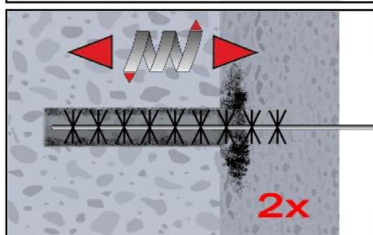

2e. Brush the bore hole minimum 2x with brush RB according to Table B4 over the entire embedment depth in a twisting motion. (If necessary, a brush extension shall be used.)

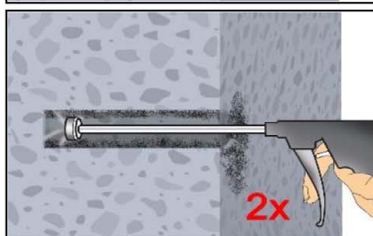

2f. Finally blow the bore hole clean minimum 2x with compressed air (min. 6 bar) (Annex B 4) over the entire embedment depth until return air stream is free of noticeable dust. (If necessary, an extension shall be used.)

Protect cleaned bore hole against re-contamination in an appropriate way. If necessary, repeat cleaning process directly before dispensing the mortar. In-flowing water must not contaminate the bore hole again.

CELO Injection system ResiFIX Pure Epoxy for rebar connection

Intended use

Installation instructions (continuation)

Annex B 8

Installation instructions (continuation)

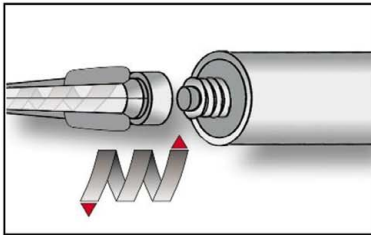

3. Screw on static-mixing nozzle MDE, and load the cartridge into an appropriate dispensing tool.
For every working interruption longer than the maximum working time t_{work} (Annex B 5) as well as for new cartridges, a new static-mixer shall be used.

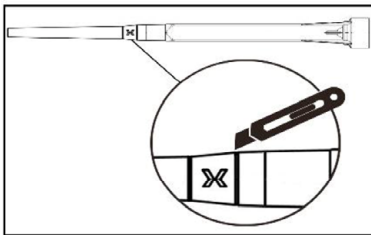

- 3a. In case of using the mixer extension VL16/1,8, cut off the tip of the mixer nozzle at position „X“.

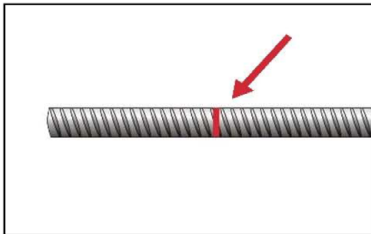

4. Mark embedment depth on the reinforcing bar .
The reinforcing bar shall be free of dirt, grease, oil or other foreign material.

5. Mark mixer nozzle and extension with mortar level mark l_m and anchorage depth l_v resp. $l_{e,ges}$

Quick estimation: $l_m = 1/3 \cdot l_v$

Optimum mortar volume:

$$l_m = l_v \text{ resp. } l_{e,ges} \cdot \left(1,2 \cdot \frac{\phi^2}{d_0^2} - 0,2 \right)$$

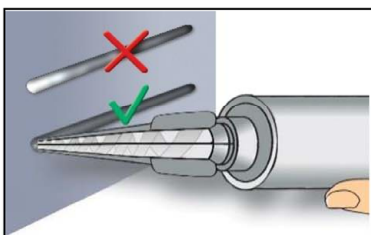
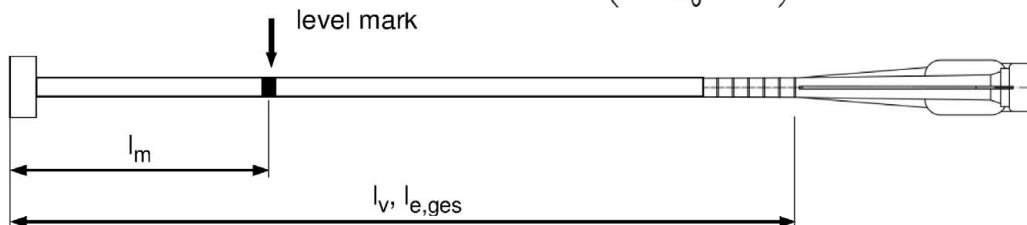

6. Not proper mixed mortar is not sufficient for fastening.
Dispense and discard mortar until an uniform grey or red colour is shown (at least 3 full strokes).

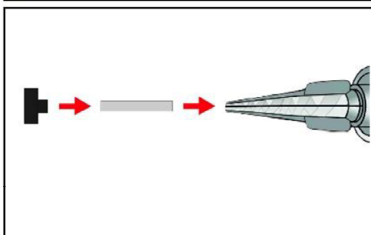

7. Piston plugs VS and mixer nozzle extensions VL shall be used according to Table B3.
Assemble mixing nozzle, mixer extension and piston plug before injecting mortar.

CELO Injection system ResiFIX Pure Epoxy for rebar connection

Intended Use

Installation instructions (continuation)

Annex B 9

Installation instructions (continuation)

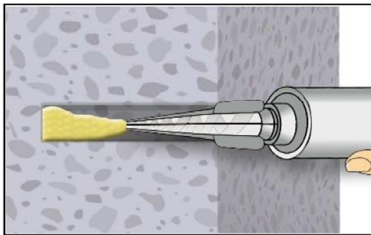

8a. Injecting mortar without piston plug VS:
Starting at bottom of the hole and fill the hole with adhesive until the mortar level mark is visible. (If necessary, a mixer nozzle extension shall be used.) Slowly withdraw of the static mixing nozzle avoid creating air pockets. Observe the temperature related working time t_{work} (Annex B 5).

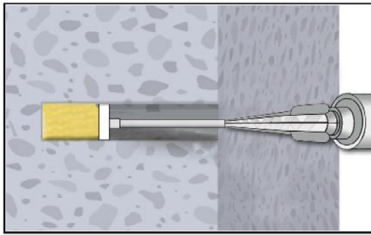

8b. Injecting mortar with piston plug VS:
Insert piston plug to bottom of the hole and fill the hole with mortar until mortar level mark l_m is visible. (If necessary, a mixer nozzle extension shall be used.) During injection the piston plug is pushed out of the bore hole by the back pressure of the mortar. Observe the temperature related working time t_{work} (Annex B 5).

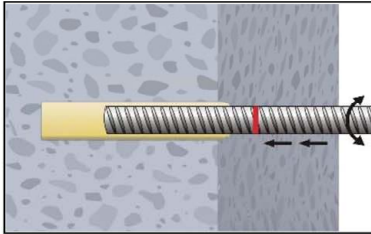

9. Insert the reinforcing bar while turning slightly up to the embedment mark.

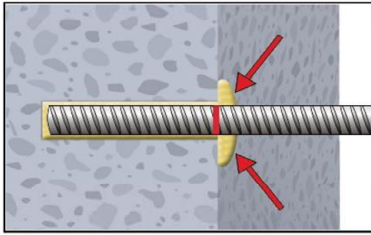

10. Annular gap between reinforcing bar and base material must be completely filled with mortar. Otherwise, the installation must be repeated starting from step 8 before the maximum working time t_{work} has expired.

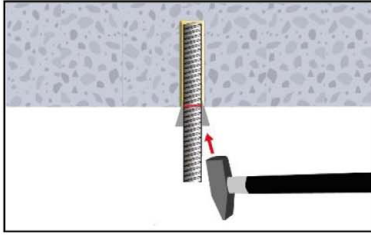

11. For application in vertical upwards direction the reinforcing bar shall be fixed (e.g. wedges).

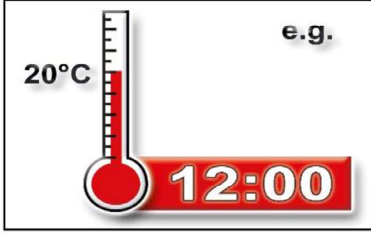

12. Temperature related curing time t_{cure} (Annex B 5) must be observed. Do not move or load the reinforcing bar during curing time.

CELO Injection system ResiFIX Pure Epoxy for rebar connection

Intended Use
Installation instructions (continuation)

Annex B 10

Minimum anchorage length and minimum lap length under static or quasi-static loading

The minimum anchorage length $l_{b,min}$ and the minimum lap length $l_{0,min}$ according to EN 1992-1-1:2004+AC:2010 ($l_{b,min}$ acc. to Eq. 8.6 and Eq. 8.7 and $l_{0,min}$ acc. to Eq. 8.11) shall be multiply by the amplification factor $\alpha_{lb} = \alpha_{lb,100y}$ according to Table C2.

Table C1: Amplification factor α_{lb} related to concrete class and drilling method

Concrete class	Drilling method	Bar size	Amplification factor α_{lb}
C12/15 to C50/60	HD: Hammer drilling HDB: Hammer drilling with hollow drill bit CD: Compressed air drilling	8 mm to 40 mm	1,0
C12/15 to C50/60	DD: Diamond drilling	8 mm to 40 mm	1,5

Table C2: Reduction factor k_b

Rebar	Drilling method	Concrete class									
		ϕ	C12/15	C16/20	C20/25	C25/30	C30/37	C35/45	C40/50	C45/55	C50/60
8 to 40 mm	HD HDB CD		1,0								
8 to 40 mm	DD		1,0			0,9	0,79	0,73	0,68	0,63	

Table C3: Design values of the ultimate bond stress $f_{bd,PIR}$ in N/mm² for all drilling methods and for good conditions

$$f_{bd,PIR} = k_b \cdot f_{bd}$$

with

f_{bd} : Design value of the ultimate bond stress in N/mm² considering the concrete classes, the rebar diameter, the drilling method for good bond condition (for all other bond conditions multiply the values by $\eta_1 = 0.7$) and recommended partial factor $\gamma_c = 1,5$ according to EN 1992-1-1:2004+AC:2010.

k_b : Reduction factor according to Table C2

Rebar	Drilling method	Concrete class									
		ϕ	C12/15	C16/20	C20/25	C25/30	C30/37	C35/45	C40/50	C45/55	C50/60
8 to 32 mm	HD HDB CD		1,6	2,0	2,3	2,7	3,0	3,4	3,7	4,0	4,3
34 mm			1,6	2,0	2,3	2,6	2,9	3,3	3,6	3,9	4,2
36 mm			1,5	1,9	2,2	2,6	2,9	3,3	3,6	3,8	4,1
40 mm			1,5	1,8	2,1	2,5	2,8	3,1	3,4	3,7	4,0
8 to 32 mm	DD		1,6	2,0	2,3	2,7					
34 mm			1,6	2,0	2,3	2,6					
36 mm			1,5	1,9	2,2	2,6					
40 mm			1,5	1,8	2,1	2,5					

CELO Injection system ResiFIX Pure Epoxy for rebar connection

Performances

Minimum anchorage length and minimum lap length, Amplification factor, Reduction factor and Design values of ultimate bond resistance

Annex C 1

Design value of the ultimate bond stress $f_{bd,fi}$ at increased temperature for concrete classes C12/15 to C50/60, (all drilling methods):

The design value of the bond stress $f_{bd,fi}$ at increased temperature has to be calculated by the following equation:

$$f_{bd,fi} = k_{fi}(\theta) \cdot f_{bd,PIR} \cdot \gamma_C / \gamma_{M,fi}$$

with: $\theta \leq 140^\circ\text{C}$: $k_{fi}(\theta) = 5862 \cdot \theta^{-1,657} / (f_{bd,PIR} \cdot 4,3) \leq 1,0$
 $\theta > 140^\circ\text{C}$: $k_{fi}(\theta) = 0$

$f_{bd,fi}$ Design value of the ultimate bond stress at increased temperature in N/mm^2

θ Temperature in $^\circ\text{C}$ in the mortar layer.

$k_{fi}(\theta)$ Reduction factor at increased temperature.

$f_{bd,PIR}$ Design value of the bond stress in N/mm^2 in cold condition according to Table C3 considering the concrete classes, the rebar diameter, the drilling method and the bond conditions according to EN 1992-1-1:2004+AC:2010.

γ_C = 1,5, recommended partial factor according to EN 1992-1-1:2004+AC:2010

$\gamma_{M,fi}$ = 1,0, recommended partial factor according to EN 1992-1-2:2004+AC:2008

For evidence at increased temperature the anchorage length shall be calculated according to EN 1992-1-1:2004+AC:2010 Equation 8.3 using the temperature-dependent design value of ultimate bond stress $f_{bd,fi}$.

Example graph of Reduction factor $k_{fi}(\theta)$ for concrete classes C20/25 for good bond conditions:

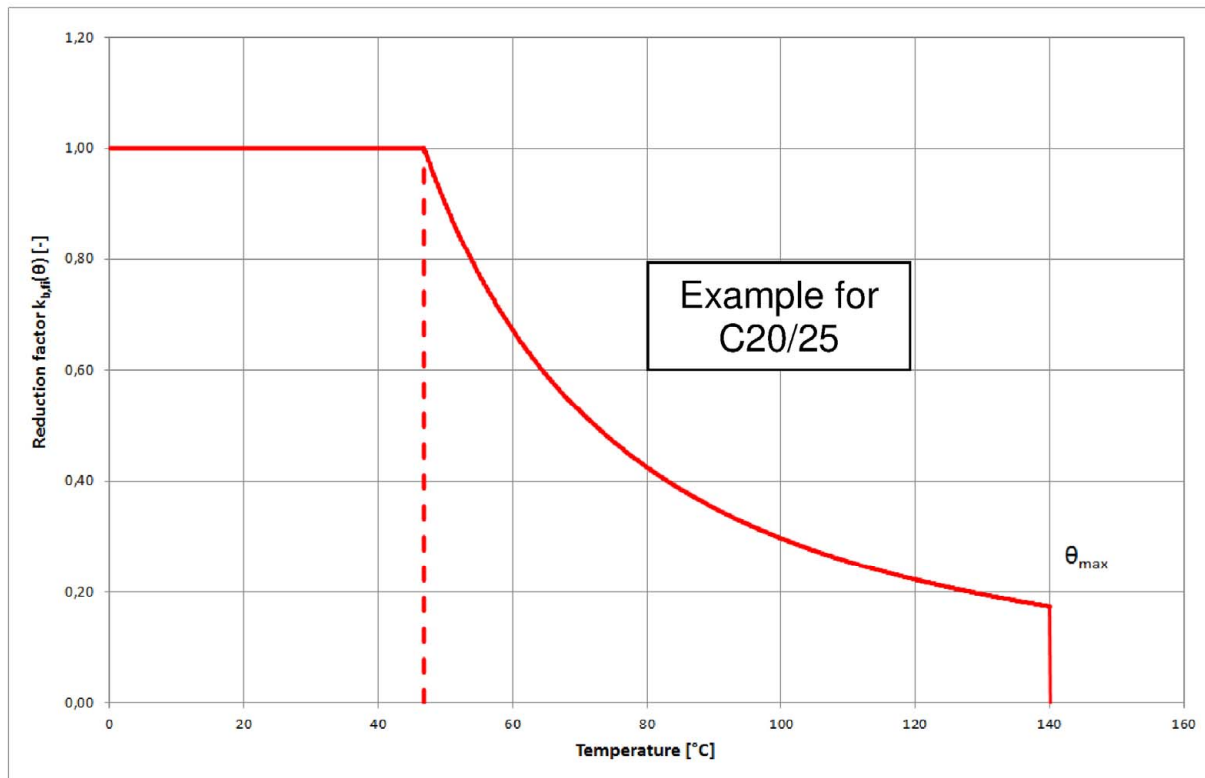

CELO Injection system ResiFIX Pure Epoxy for rebar connection

Performances

Design value of ultimate bond stress at increased temperature

Annex C 2